

FR G1/2 5 μ -10BAR MAN.Ø50 AUTODR.BG3

Product Images

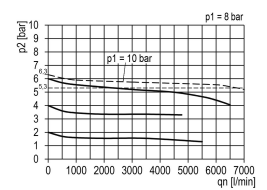

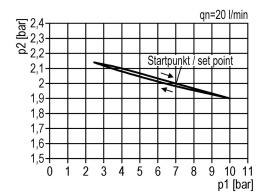
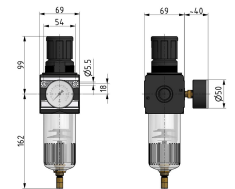
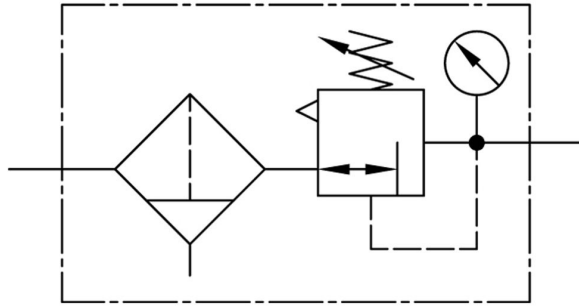

Additional Information

EAN Code	8719426446157
Artikelnummer	KN-C33/10/GAM
Bouwgrootte	Bouwgrootte 3
Filtergrootte (micron)	5
FRL functie	Filter / reduceer
Aansluiting manometer	Nee
FRL specificatie	Filter/drukregelaar 5 micron met vlotter
Maximaal regelbereik (bar)	16
Minimaal Regelbereik (bar)	1
Vlotter	Nee
Geschikt voor bouwgrootte (multi-fix)	1/2" bouwgrootte 3
Merk	Knocks
Aansluitmaat	1/2" BSPP
Max. druk	16 bar
Regelbare druk	10 bar